

Classic Traditional[®]

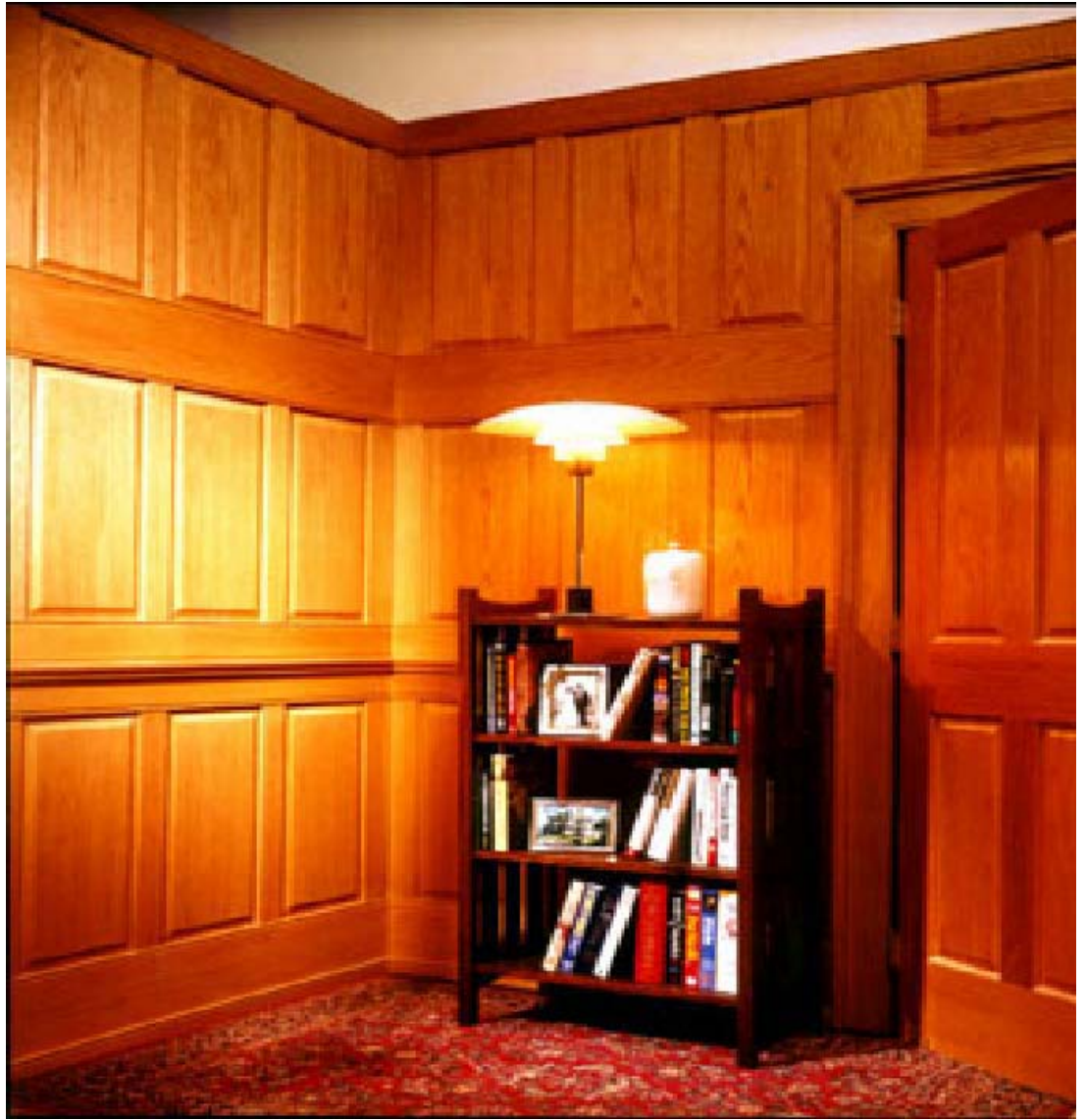

New England Classic[®] brings back the warmth and beauty of fine wood interiors. The Classic Traditional[®] Raised Panel System uses wood panels to accentuate and enhance virtually any interior space.

The system is designed using components that complement each other and provide high quality, fully coordinated interior solutions.

The panel system uses select Grade-A sliced veneer or decorative film laminated to a stable engineered wood core. The engineered wood core is more stable than solid wood. It is also less susceptible to shrinkage, twisting and splitting.

A variety of panel sizes, along with precision machined rails and

stiles, create a fully integrated assembly system. Sizes range from 32" to full room ceiling height configurations. Stair PanelSets[®] allow you to continue the panel treatment up the stairs. Custom sizes may also be specified.

The panel veneers include oak, maple, cherry as well as a primed finish, available ready - to - finish or factory finished. For an upcharge, we will match any color stain you desire.

The Classic Traditional[®] Raised Panel System is the perfect way to achieve the high quality look and feel of custom millwork, at a fraction of the cost.

Classic Traditional[®] Systems

Typical one-tier raised panel systems shown. Two-tier and multiple tier wall configurations are available including full height applications. Please visit www.newenglandclassic.com for more product information and details.

Wall Panel System

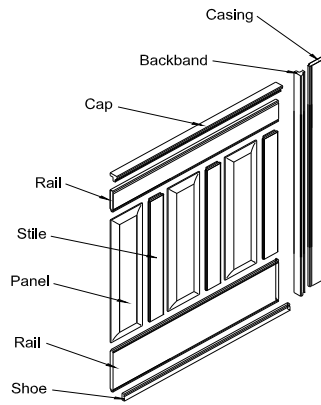

Stair Panel System

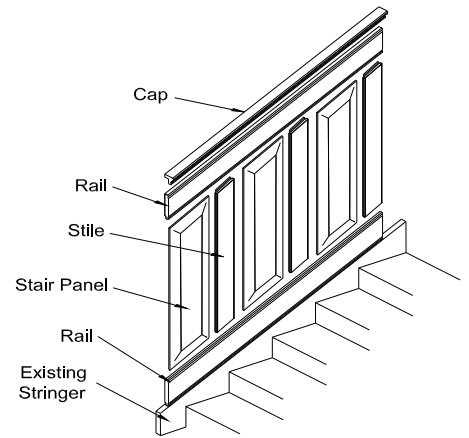

Classic Traditional[®] Components are packaged for convenient ordering, handling and use.

PanelSet[®]

Available in 9", 12", 15", 18" & 23" Widths and either 23" or 31" Heights.

Each package contains:

- 4 - Panels
- 4 - Center stiles (3" wide)

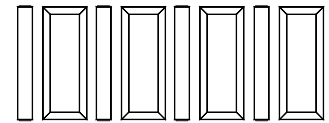

FramePak[®]

Available with either 4" (32" FramePak[®]) or 8" (36" FramePak[®]) base rail.

Each package contains (96" length):

- 1 - Cap
- 1 - Top rail
- 1 - Bottom rail (4" or 8")
- 1 - Shoe



StilePak[®]

Adjusts layout to fit variable wall lengths, complete corners and window by trimming to desired width.

Each package contains:

- 4 - end stiles (10" wide)



6" PanelSet[®]

Adjusts the layout to fit variable wall lengths.

Each package contains:

- 4 - Panels (6" wide)

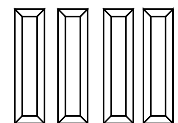

CasingPak[®]

Window and door trim designed to match.

Each package contains (96" length):

- 3 - Caps
- 3 - Rails



Stair PanelSet[®]

Available in 2 angles 37° and 41° (Left & Right)

Each package contains:

- 2 - Panels (9" wide)
- 2 - Stiles (3"x23")

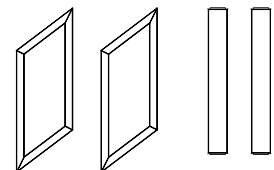

Stair StilePak[®]

Adjusts the layout to fit variable length stairs and to transition from the stair to the horizontal run at the top and bottom of stairs.

Each package contains:

- 2 - Stiles (10"x 28")

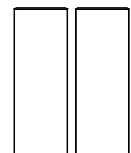

Classic Traditional[®] Stair Panels

Stair panels are trimmable up to 1 1/2° variance.

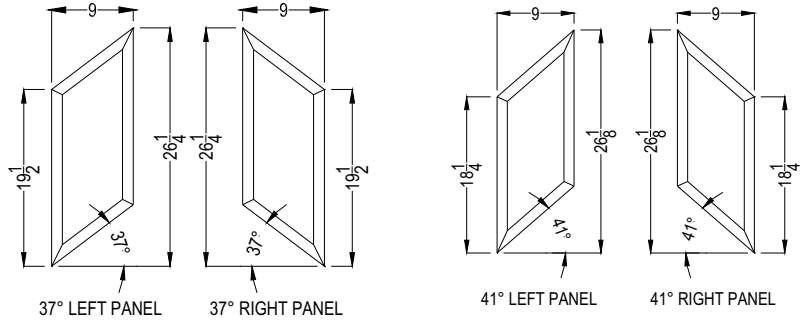

Classic Traditional[®] Components

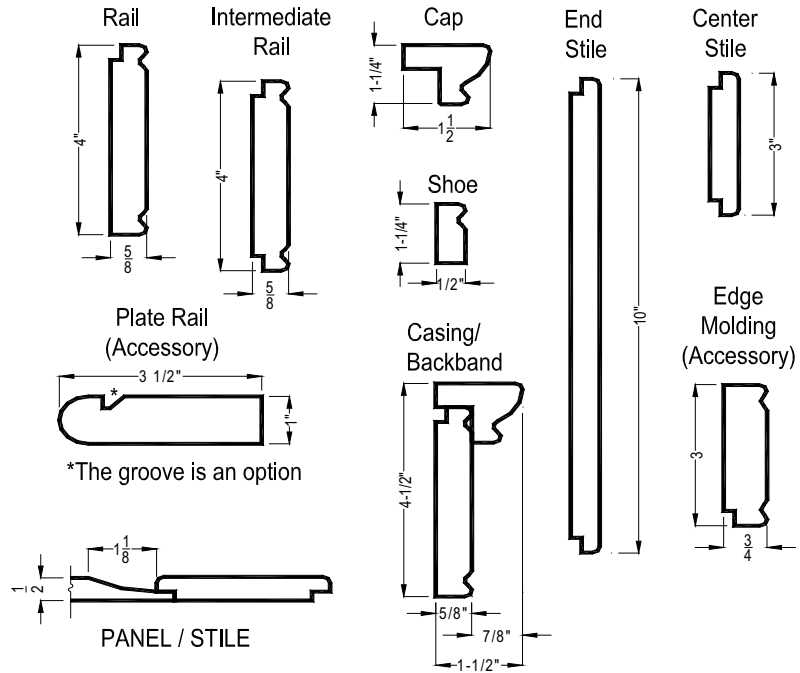

Classic Traditional[®] Panels & Stiles (Exposed Sizes)

Boxed PanelSets[®] are available in the these configuration sizes only:

6" x 23", 9" x 23", 12" x 23", 15" x 23", 18" x 23", 23" x 23"

Other panel and stile sizes are ordered separately.

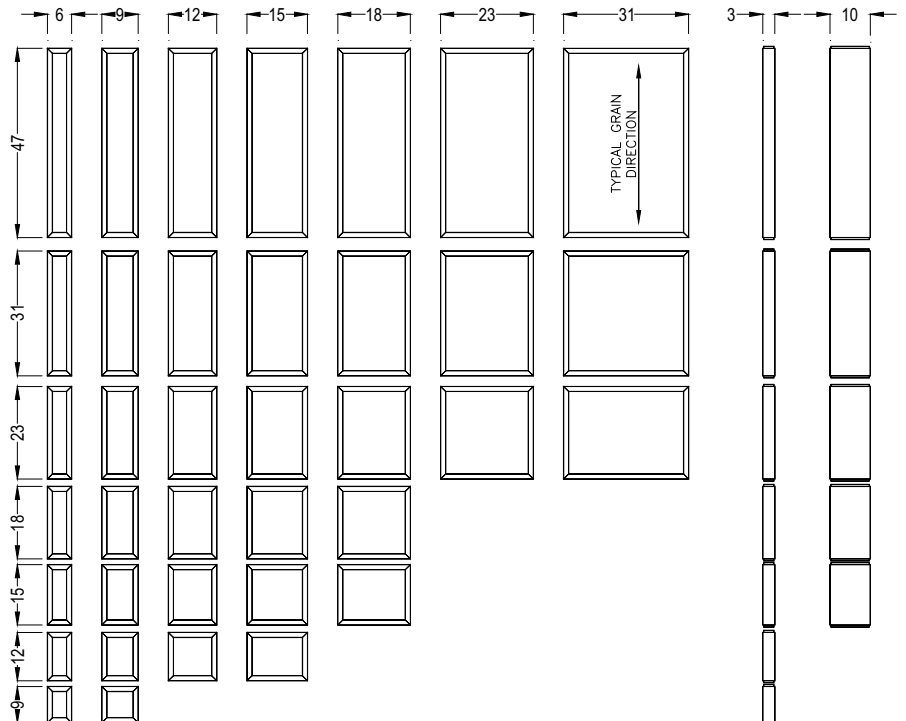

PART 1.0 GENERAL

1.1 DESCRIPTION

A. Raised panel wainscoting and wall panel systems shall be the New England Classic® Classic Traditional® Raised Panel system manufactured by New England Classic®.

1.2 SUBMITTALS

B. Submit manufacturer's literature and installation instructions to determine layout requirements

1.3 DELIVERY, STORAGE, AND HANDLING

A. Delivery of Product: The Classic Traditional® panel system shall be delivered to the job site in the manufacturer's original packaging with manufacturer's identification intact and legible.

B. Storage & handling: The Classic Traditional® panel system shall be stored and handled in such a way to protect against contact with water, exposure to weather, breakage and damage. Do not store directly on concrete without a plastic sheet as a moisture barrier.

1.4 LIMITATIONS

A. Moisture Conditions: The Classic Traditional® panel system shall not be used in wet or damp areas.

B. Temperature conditions: The Classic Traditional® panel system shall not be used in contact with surfaces where temperatures exceed 120° F.

PART 2.0 PRODUCTS

2.1 ACCEPTABLE MANUFACTURER

New England Classic
4145 Parkway Drive
Florence, AL 35630

2.2 MATERIALS

A. Substrate shall be industrial grade class 3; moisture resistant MDF, product class MD; or class 1 (fire retardant) - that conform with ANSI A208.2-1994. As an option where permitted by code, non-fire retardant substrate may be sprayed with a fire retardant finish to achieve a class 1 fire rating.

B. Adhesive for bonding veneers to substrate shall be PVA, EVA, or PUR type adhesive.

C. Real wood veneer shall be grade-A, sanded to 180 grit.

D. Factory finish shall be either lacquer or conversion varnish per Architectural Woodwork Institute (AWI) Custom Grade Specifications: TR-2 and OP-2 for lacquer, and TR-4 and OP-4 for conversion varnish finish.

2.3 COMPONENTS

A. 6" Raised Panel
6s/8"x9 1/2"x 1/2" thick
6s/8"x12 1/2"x 1/2" thick
6s/8"x15 1/2"x 1/2" thick
6s/8"x18 1/2"x 1/2" thick
6s/8"x23 1/2"x 1/2" thick
6s/8"x31 1/2"x 1/2" thick
6s/8"x47 1/2"x 1/2" thick

B. 9" Raised panel
9s/8"x9 1/2"x 1/2" thick
9s/8"x12 1/2"x 1/2" thick
9s/8"x15 1/2"x 1/2" thick
9s/8"x18 1/2"x 1/2" thick
9s/8"x23 1/2"x 1/2" thick
9s/8"x31 1/2"x 1/2" thick
9s/8"x47 1/2"x 1/2" thick

C. 12" Raised panel
12s/8"x12 1/2"x 1/2" thick
12s/8"x15 1/2"x 1/2" thick
12s/8"x18 1/2"x 1/2" thick
12s/8"x23 1/2"x 1/2" thick
12s/8"x31 1/2"x 1/2" thick
12s/8"x47 1/2"x 1/2" thick

D. 15" Raised Panel
15s/8"x15 1/2"x 1/2" thick
15s/8"x18 1/2"x 1/2" thick
15s/8"x23 1/2"x 1/2" thick

E. 18" Raised Panel
18s/8"x18 1/2"x 1/2" thick
18s/8"x23 1/2"x 1/2" thick
18s/8"x31 1/2"x 1/2" thick
18s/8"x47 1/2"x 1/2" thick

F. 23" Raised Panel
23s/8"x23 1/2"x 1/2" thick
23s/8"x31 1/2"x 1/2" thick
23s/8"x47 1/2"x 1/2" thick

G. 31" Raised Panel
31s/8"x23 1/2"x 1/2" thick
31s/8"x31 1/2"x 1/2" thick
31s/8"x47 1/2"x 1/2" thick

H. 9" Stair Panels
9s/8"x21 1/2"x 1/2" thick (37°)
9s/8"x20 1/2"x 1/2" thick (41°)

I. Cap:
1 1/2" x 1 1/4" x 96" long

J. Rail(s):
s/8" x 4" x 96" long
s/8" x 8" x 96" long

K. Shoe:
s/8" x 1 1/4" x 96" long

L. Center stile:
1/2" x 3" x panel height

M. End stile:
1/2" x 10" x panel height

N. Plate shelf:
1" x 3 1/2" x 96" long

O. Edge Molding:
3/4" x 3" x 96" long

PART 3.0 INSTALLATION

3.1 INSTALLATION

A. Install per the manufacturer's recommendations using the provided instructions.

3.2 WARRANTY

A. Manufacturer shall furnish a five year warranty against defects in material, de-lamination and workmanship for parts only. Removal labor, reinstallation labor and freight are not included.

3.3 MATERIALS ACCEPTANCE

A. City of New York
MEA 190-99-M

PART 4.0 FINISHING & MAINTENANCE

4.1 UNFINISHED OAK, MAPLE, CHERRY

A. Fill all nail holes and splices with matching wood filler. Sand wood filler patches smooth to the veneer surface with 180 grit paper, taking care not to sand through the veneer. Apply stain, sealer and clear finish coat, lightly sanding between coats with 220 grit paper. We recommend applying a light coat of lemon oil or furniture oil to replenish the natural sheen, especially in dry environments.

4.2 FINISHED

A. Use matching color putty to fill fastener holes. A matching stain kit is included with factory finished product.

4.3 PRIMED

A. It is not necessary to prime stiles, rails, shoe, cap, or casing (or factory-primed panels). After installation, apply one coat of paint to all panels. DO NOT SAND STILES, RAILS, SHOE, CAP, OR CASING. Fill in nail holes with a paintable vinyl-based spackle. Finish coat all parts together. Gentle household cleaners may be used, if required.



What better walls are wearing®

New England Classic
4145 Parkway Drive
Florence, AL 35630
(888) 460-6324
Fax (256) 767-2916
NewEnglandClassic.com